

FURNITURE

2000

2001

2002

2003

2004

2005

2006

2007

2008

2009

2010

2011

2012

2013

2014

2015

2016

2017

2018

2019

2020

exhibit
systems ●●●●
creative solutions for any event

canton
setting



- white (090101) \$295⁰⁰
- black (090102) \$295⁰⁰
- beech (090104) \$295⁰⁰
- blue (090105) \$295⁰⁰

1x round bella table (760mm height)
4x canton chairs

vogue
setting



- red (090203) \$295⁰⁰

1x round bella table (760mm height)
4x vogue chairs

betis
setting



- black (090302) \$275⁰⁰
- grey (090309) \$275⁰⁰

1x square aluminium cafe table (760mm height)
4x betis chairs

sangrita
setting



- white (090401) \$330⁰⁰
- black (090402) \$330⁰⁰

1x round bella bar table (1045mm height)
3x sangrita stools

jetson
setting



- white (090501) \$315⁰⁰
- black (090502) \$315⁰⁰
- red (090503) \$315⁰⁰

1x round bella bar table (1045mm height)
3x jetson stools

florida
setting



- black (090602) \$275⁰⁰

1x round bella bar table (1045mm height)
3x florida stools

setting



george

- white (100101) \$370⁰⁰
- black (100102) \$370⁰⁰
- red (100103) \$370⁰⁰
- blue (100105) \$370⁰⁰

1x TT coffee table (900 x 450mm)
4x george ottomans

setting



euro

- white (100201) \$330⁰⁰
- black (100202) \$330⁰⁰

1x TT coffee table (970 x 450mm)
2x euro ottomans

setting



roma

- black (100302) \$480⁰⁰

1x bella coffee table (440mm height)
2x roma chairs

setting



swan

- red (100403) \$520⁰⁰

1x bella coffee table (440mm height)
2x swan chairs

setting



milan
single

- black (100502) \$440⁰⁰

1x black TT square coffee table (750 x 750mm)
2x single milan lounges

setting



milan
double

- black (100602) \$640⁰⁰

1x black TT coffee table (900 x 450mm)
2x double milan lounges

chair
canton



○ white (010101) \$50⁰⁰
plastic seat
chrome legs

chair
canton



● black (010102) \$50⁰⁰
plastic seat
chrome legs

chair
canton



● beech (010104) \$50⁰⁰
timber seat
chrome legs

chair
canton



● navy blue (010105) \$50⁰⁰
plastic seat
chrome legs

chair
betis



● black (010202) \$50⁰⁰
plastic seat
aluminium legs

chair
betis



● grey (010209) \$50⁰⁰
plastic seat
aluminium legs

chair
harvard



● grey (010309) \$45⁰⁰
plastic seat
chrome legs

chair
stanford



● grey (010409) \$45⁰⁰
upholstered seat
chrome legs

chair
vogue



● red (010503) \$50⁰⁰
plastic seat
chrome legs

chair
folding



● black (010602) \$38⁰⁰
plastic seat
chrome legs

chair
typist



● grey (010709) \$49⁰⁰
upholstered cushioned seat
adjustable height
castors

chair
clerical



● grey (010809) \$55⁰⁰
upholstered cushioned seat
castors
arm rests

chair
clerical



● orange (010811) \$50⁰⁰
upholstered cushioned seat
castors
arm rests

chair
clerical



● teal (010812) \$50⁰⁰
upholstered cushioned seat
castors
arm rests



stool

jetson



○ white (020201) \$85⁰⁰

plastic seat
adjustable height chrome base

stool

jetson



● black (020202) \$85⁰⁰

plastic seat
adjustable height chrome base

stool

jetson



● red (020203) \$85⁰⁰

plastic seat
adjustable height chrome base

stool

ikon



● black (020402) \$85⁰⁰

cushioned upholstered seat
chrome legs

stool

sangrita



○ white (020301) \$90⁰⁰

upholstered seat
adjustable height chrome base

stool

sangrita



● black (020302) \$90⁰⁰

upholstered seat
adjustable height chrome base

stool

florida



● black (020102) \$70⁰⁰

upholstered cushioned seat
chrome base

stool

miami



○ white (020801) \$70⁰⁰

● black (020802) \$70⁰⁰

● red (020803) \$70⁰⁰

● beech (020804) \$70⁰⁰

● blue (020805) \$70⁰⁰

● yellow (020807) \$70⁰⁰

chrome base

stool

vogue



● black (020602) \$75⁰⁰

plastic seat with backrest
chrome legs

stool

drafting



● black (020702) \$75⁰⁰

upholstered seat with backrest
gas-lift height adjustable
600-700mm seat height

ottoman

euro



○ white (030201) \$125⁰⁰

vinyl upholstery
cushioned seat
chrome base
1500(w) x 420(d) x 450mm(h)

ottoman

euro



● black (030202) \$125⁰⁰

vinyl upholstery
cushioned seat
chrome base
1500(w) x 420(d) x 450mm(h)

ottoman

george



○ white (030101) \$75⁰⁰

vinyl upholstery
cushioned seat
420(w) x 420(d) x 450mm(h)

ottoman

george



● black (030102) \$75⁰⁰

vinyl upholstery
cushioned seat
420(w) x 420(d) x 450mm(h)

ottoman

george



● red (030103) \$75⁰⁰

vinyl upholstery
cushioned seat
420(w) x 420(d) x 450mm(h)

ottoman

george

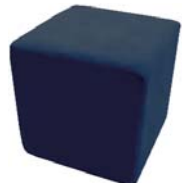

● blue (030105) \$75⁰⁰

vinyl upholstery
cushioned seat
420(w) x 420(d) x 450mm(h)

furniture | lounges

milan
1-seater

lounge



● black (030402) \$175⁰⁰

leather upholstery
chrome frame

milan
2-seater

lounge



● black (030502) \$275⁰⁰

leather upholstery
chrome frame

roma chair

lounge



● black (030702) \$245⁰⁰

velour upholstery
chrome base

swan chair

lounge



● red (030603) \$295⁰⁰

velour upholstery
chrome base

furniture | tables

bella 800

table



○ white (040101) \$90⁰⁰

● black (040102) \$90⁰⁰

● red (040103) \$90⁰⁰

● beech (040104) \$90⁰⁰

● blue (040105) \$90⁰⁰

● yellow (040107) \$90⁰⁰

● wenge (040115) \$90⁰⁰

800mm diameter
760mm height

bella bar

table

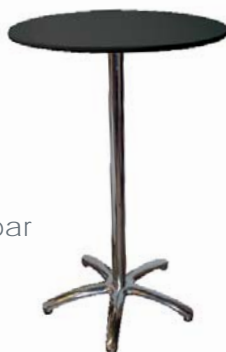

○ white (040201) \$95⁰⁰

● black (040202) \$95⁰⁰

● red (040203) \$95⁰⁰

● beech (040204) \$95⁰⁰

● blue (040205) \$95⁰⁰

● yellow (040207) \$95⁰⁰

● wenge (040215) \$95⁰⁰

700mm diameter
1045mm height

bella
coffee

table



○ white (040301) \$85⁰⁰

● black (040302) \$85⁰⁰

● red (040303) \$85⁰⁰

● beech (040304) \$85⁰⁰

● blue (040305) \$85⁰⁰

● yellow (040307) \$85⁰⁰

● wenge (040315) \$85⁰⁰

700mm diameter
440mm height

square cafe

table



● alloy (040414) \$75⁰⁰

600(w) x 600(d) x 760mm(h)

TT
coffee

table



○ white (040601) \$90⁰⁰

● black (040602) \$90⁰⁰

● red (040603) \$90⁰⁰

● beech (040604) \$90⁰⁰

● blue (040605) \$90⁰⁰

● wenge (040615) \$90⁰⁰

900(w) x 450(d) x 430mm(h)

TT square
coffee

table



○ white (040701) \$90⁰⁰

● black (040702) \$90⁰⁰

● red (040703) \$90⁰⁰

● beech (040704) \$90⁰⁰

● blue (040705) \$90⁰⁰

● wenge (040715) \$90⁰⁰

750(w) x 750(d) x 430mm(h)



elite meeting table

- white (040901) \$120⁰⁰
- black (040902) \$120⁰⁰
- beech (040904) \$120⁰⁰
- wenge (040915) \$120⁰⁰

2100(w) x 900(d) x 750mm(h)



elite table

- white (041001) \$99⁰⁰
- black (041002) \$99⁰⁰
- red (041003) \$99⁰⁰
- beech (041004) \$99⁰⁰
- blue (041005) \$99⁰⁰
- wenge (041015) \$99⁰⁰

1500(w) x 750(d) x 740mm(h)



elite square table

- white (040801) \$80⁰⁰
- black (040802) \$80⁰⁰
- red (040803) \$80⁰⁰
- beech (040804) \$80⁰⁰
- blue (040805) \$80⁰⁰
- wenge (040815) \$80⁰⁰

750(w) x 750(d) x 740mm(h)



covered trestle table

- white cloth (041101) \$94⁰⁰
- black cloth (041102) \$94⁰⁰

1830(w) x 760(d) x 760mm(h)



plastic trestle 1800 table

- grey plastic (041209) \$62⁰⁰

1830(w) x 760(d) x 760mm(h)



plastic trestle 1500 table

- grey plastic (041109) \$48⁰⁰

1500(w) x 760(d) x 760mm(h)

furniture | counters & desks



octa curved counter

- white (050801) \$215⁰⁰
- black (050802) \$215⁰⁰
- red (050803) \$215⁰⁰
- beech (050804) \$215⁰⁰
- blue (050805) \$215⁰⁰
- yellow (050807) \$215⁰⁰

+ digital print front +\$200⁰⁰
1440(w) x 730(d) x 1000mm(h)
open at back

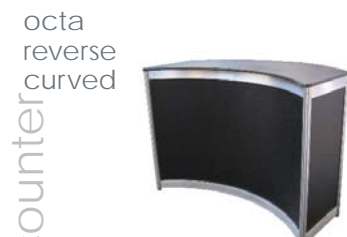

octa reverse curved counter

- white (050901) \$215⁰⁰
- black (050902) \$215⁰⁰
- red (050903) \$215⁰⁰
- beech (050904) \$215⁰⁰
- blue (050905) \$215⁰⁰
- yellow (050907) \$215⁰⁰

+ digital print front +\$200⁰⁰
1440(w) x 730(d) x 1000mm(h)
open at back



octa curved registration counter

- white (051501) \$295⁰⁰
- black (051502) \$295⁰⁰
- red (051503) \$295⁰⁰
- beech (051504) \$295⁰⁰
- blue (051505) \$295⁰⁰
- yellow (051507) \$295⁰⁰

+ digital print front +\$200⁰⁰
1440(w) x 935(d) x 1200/900mm(h)
open at back
raised hob at front



octa curved reception counter

- white (050701) \$275⁰⁰
- black (050702) \$275⁰⁰
- red (050703) \$275⁰⁰
- beech (050804) \$275⁰⁰
- blue (050705) \$275⁰⁰
- yellow (050807) \$275⁰⁰

+ digital print front +\$200⁰⁰
1440(w) x 730(d) x 1200/900mm(h)
open at back
raised hob at front



octa lockable counter

- white (050201) \$220⁰⁰
- black (050202) \$220⁰⁰
- red (050203) \$220⁰⁰
- beech (050204) \$220⁰⁰
- blue (050205) \$220⁰⁰
- yellow (050207) \$220⁰⁰

+ digital print front +\$150⁰⁰
1030(w) x 535(d) x 1000mm(h)
lockable door
internal shelf



octa glass top counter

- white (050401) \$230⁰⁰
- black (050402) \$230⁰⁰
- red (050403) \$230⁰⁰
- beech (050404) \$230⁰⁰
- blue (050405) \$230⁰⁰
- yellow (050407) \$230⁰⁰

+ digital print front +\$150⁰⁰
1030(w) x 535(d) x 1200mm(h)
lockable door
internal shelf

octa
registration
counter



- white (050101) \$230⁰⁰
 - black (050102) \$230⁰⁰
 - red (050103) \$230⁰⁰
 - beech (050104) \$230⁰⁰
 - blue (050105) \$230⁰⁰
 - yellow (050107) \$230⁰⁰
 - + digital print front +\$150⁰⁰
- 1030(w) x 785(d) x 1200/900mm (h)
open at back

octa
reception
counter



- white (050501) \$250⁰⁰
 - black (050502) \$250⁰⁰
 - red (050503) \$250⁰⁰
 - beech (050504) \$250⁰⁰
 - blue (050505) \$250⁰⁰
 - yellow (050507) \$250⁰⁰
 - + digital print front +\$150⁰⁰
- 1030(w) x 785(d) x 1200/900mm(h)
lockable door

octa
desk



- white (050601) \$140⁰⁰
 - black (050602) \$140⁰⁰
 - red (050603) \$140⁰⁰
 - beech (050604) \$140⁰⁰
 - blue (050605) \$140⁰⁰
 - yellow (050607) \$140⁰⁰
 - + digital print front +\$165⁰⁰
- 1565(w) x 780(d) x 785mm(h)
open back

octa
corner
counter



- white (051301) \$250⁰⁰
 - black (051302) \$250⁰⁰
 - red (051303) \$250⁰⁰
 - beech (051304) \$250⁰⁰
 - blue (051305) \$250⁰⁰
 - yellow (051307) \$250⁰⁰
- 1440(w) x 740(d) x 1000mm(h)
lockable doors

octa
computer
module
counter



- white (050301) \$140⁰⁰
 - black (050302) \$140⁰⁰
 - red (050303) \$140⁰⁰
 - beech (050304) \$140⁰⁰
 - blue (050305) \$140⁰⁰
 - yellow (050307) \$140⁰⁰
 - + digital print front +\$90⁰⁰
- 565(w) x 700(d) x 1000mm(h)
lockable door
internal shelf

octa
demo pod
counter



- white (051401) \$795⁰⁰
 - black (051402) \$795⁰⁰
 - red (051403) \$795⁰⁰
 - beech (051404) \$795⁰⁰
 - blue (051405) \$795⁰⁰
 - yellow (051407) \$795⁰⁰
- 1030(w) x 660(d) x 2440mm(h)
lockable door
*includes digital print sign panel
*audio-visual ordered separately

maxima
counter



- white (051001) \$280⁰⁰
 - black (051002) \$280⁰⁰
 - red (051003) \$280⁰⁰
 - beech (051004) \$280⁰⁰
 - blue (051005) \$280⁰⁰
 - yellow (051007) \$280⁰⁰
 - + digital print front +\$165⁰⁰
- 1110(w) x 615(d) x 1200/900mm(h)
lockable door

maxima
desk
counter



- white (051101) \$320⁰⁰
 - black (051102) \$320⁰⁰
 - red (051103) \$320⁰⁰
 - beech (051104) \$320⁰⁰
 - blue (051105) \$320⁰⁰
 - yellow (051107) \$320⁰⁰
 - + digital print front +\$165⁰⁰
- 1850(w) x 615(d) x 1200/900mm(h)
lockable door
desk extension

maxima
premium
counter



- white (051201) \$460⁰⁰
 - black (051202) \$460⁰⁰
 - + digital print front +\$80⁰⁰
- 1110(w) x 665(d) x 948mm(h)
lockable door



showcase
glass
white (070101) \$230⁰⁰
950(w) x 600(d) x 1000mm(h)
lockable glass top section
lockable base cupboard

plinths

	300mm height
white (070201)	\$60 ⁰⁰
black (070202)	\$60 ⁰⁰
red (070203)	\$60 ⁰⁰
beech (070204)	\$60 ⁰⁰
blue (070205)	\$60 ⁰⁰
yellow (070207)	\$60 ⁰⁰

535(w) x 535(d) x 300mm(h)

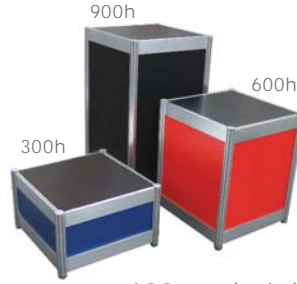

	600mm height
white (070301)	\$80 ⁰⁰
black (070302)	\$80 ⁰⁰
red (070303)	\$80 ⁰⁰
beech (070304)	\$80 ⁰⁰
blue (070305)	\$80 ⁰⁰
yellow (070307)	\$80 ⁰⁰

535(w) x 535(d) x 600mm(h)

	900mm height
white (070401)	\$120 ⁰⁰
black (070402)	\$120 ⁰⁰
red (070403)	\$120 ⁰⁰
beech (070404)	\$120 ⁰⁰
blue (070405)	\$120 ⁰⁰
yellow (070407)	\$120 ⁰⁰

535(w) x 535(d) x 900mm(h)



brochure
zig-zag
black (060702) \$95⁰⁰
A4 brochure holder
double-sided
5 shelves
1665mm height



brochure
folding
silver/clear (060808) \$95⁰⁰
folding A4 brochure holder
double-sided
6 shelves
1430mm height



brochure
fabric mesh
black/grey (061608) \$75⁰⁰
portable A4 brochure holder
4 pockets
1350mm height



brochure
fabric mesh
black/grey (061708) \$90⁰⁰
portable A4 brochure holder
8 pockets
1350mm height



brochure
acrylic
wall-mount (060601) \$20⁰⁰
desk-mount (062001) \$20⁰⁰
A4 size
clear acrylic



hanger
angled clothes
chrome (060316) \$75⁰⁰
chrome 4-way clothes hanger
height adjustable arms



hanger
level clothes
chrome (060416) \$75⁰⁰
chrome 4-way clothes hanger
height adjustable arms



display
easel
wood (062104) \$50⁰⁰
artist display easel
1400mm height



fridge
bar
white (060101) \$120⁰⁰
bar fridge with mini freezer
550(w) x 555(d) x 850mm(h)



fridge
glass display
white (062601) \$275⁰⁰
glass door display fridge
internal light
2x adjustable shelves
500(w) x 560(d) x 755mm(h)



fridge
& freezer
white (060201) \$240⁰⁰
full-height fridge
separate freezer at bottom
600(w) x 600(d) x 1715mm(h)



microwave
oven
white (061801) \$50⁰⁰
460(w) x 320(d) x 290mm(h)

ballot box



○ white (061501) \$80⁰⁰
 ● black (061502) \$80⁰⁰
 lockable with entry slot
 380(w) x 380(d) x 1000mm(h)

waste basket



● black (060502) \$15⁰⁰
 plastic - 350mm height

entry barrel



● clear (062501) \$165⁰⁰
 rotating barrel
 lockable door hatch
 white frame with castors
 700(w) x 430(d) x 1100mm(h)

table cloth



○ white (061301) \$32⁰⁰
 ● black (061302) \$32⁰⁰
 linen table cloth
 2800 x 1370mm

post & rope barrier



● chrome post (061416) \$25⁰⁰
 ● black rope (061402) \$30⁰⁰
 ● red rope (061403) \$30⁰⁰
 1500mm rope length

tensa barrier



● post & belt (062316) \$55⁰⁰
 chrome post
 retractable red belt
 1500mm length
 2 sets minimum required

cheval mirror



● chrome (063208) \$80⁰⁰
 370(w) x 490(d) x 1435mm(h)
 silver frame

coat stand



● chrome (063316) \$55⁰⁰
 1745mm (height)
 330mm (diameter)
 6x hangers

freestanding shelf display



○ white (062701) \$145⁰⁰
 freestanding shelf display
 1030(w) x 390(d) x 2000mm(h)
 3x shelves + base shelf
 angled or straight shelves

display grid



● black (070702) \$60⁰⁰
 free-standing display grid
 600(w) x 1800mm(h)

horizontal poster panel



● black (070802) \$75⁰⁰
 ● grey (070809) \$75⁰⁰
 Freestanding or linked
 velcro-compatible
 2020(w) x 1940mm(h)

vertical poster panel



● black (070902) \$75⁰⁰
 ● grey (070909) \$75⁰⁰
 Freestanding or linked
 velcro-compatible
 940(w) x 1940mm(h)

slatwall panel



○ white (070501) \$125⁰⁰
 Slatwall panel for Foga or Octanorm
 1000(w) x 2400mm(h) approx.
 *fittings ordered separately

freestanding unit slatwall



○ white (070601) \$275⁰⁰
 freestanding 2-sided unit
 slatwall 3 sides
 clothes hanger at end
 1800(w) x 600(d) x 1300mm(h)
 *fittings ordered separately

slatwall fittings

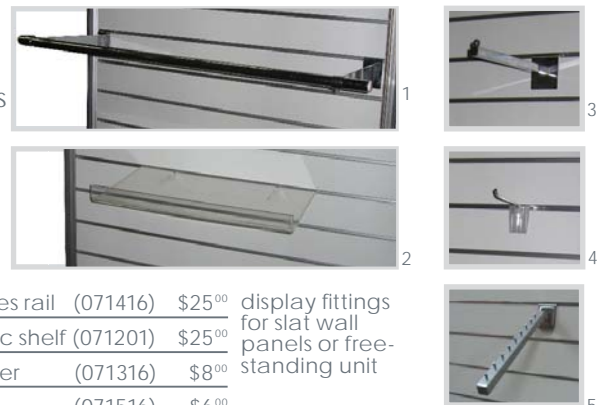

① clothes rail (071416) \$25⁰⁰
 ② acrylic shelf (071201) \$25⁰⁰
 ③ hanger (071316) \$8⁰⁰
 ④ peg (071516) \$6⁰⁰
 ⑤ waterfall (071016) \$15⁰⁰
 display fittings for slat wall panels or free-standing unit

42"
plasma
screen



- 1-2 days (080101) \$530⁰⁰
- 3 days (080102) \$690⁰⁰
- 4-7 days (080103) \$820⁰⁰

* desk mount or
* plasma stand (order separately)

LCD 32"
screen



- 1-2 days (080601) \$490⁰⁰
- 3 days (080602) \$590⁰⁰
- 4-7 days (080603) \$690⁰⁰

* desk mount or
* plasma stand (order separately)

LCD 21" TV
screen



- 1-2 days (080501) \$250⁰⁰
- 3 days (080502) \$300⁰⁰
- 4-7 days (080503) \$350⁰⁰

built-in TV tuner
*desk mount only

LCD 19"
screen



- 1-2 days (080201) \$145⁰⁰
- 3 days (080202) \$175⁰⁰
- 4-7 days (080203) \$205⁰⁰

*desk mount only

LCD 17"
screen



- 1-2 days (080301) \$100⁰⁰
- 3 days (080302) \$145⁰⁰
- 4-7 days (080303) \$165⁰⁰

*desk mount only

DVD
player



- 1-2 days (080401) \$30⁰⁰
- 3 days (080402) \$40⁰⁰
- 4-7 days (080403) \$50⁰⁰

DVD, CD, CD-R, MP3, JPEG
formats

plasma
stand



- 1-2 days (080701) \$120⁰⁰
- 3 days (080702) \$180⁰⁰
- 4-7 days (080703) \$180⁰⁰

includes shelf
landscape or portrait display
single or double screen display
*plasma screen & dvd player not
included in price



lighting & electrics

200w octanorm
arm light



○ silver (E211) POA
200w arm light
fits directly to octanorm system

120w on arm
arm light



○ white (E212) POA
100w arm light

300w barn door
arm light



○ white/silver (E213) POA
300w arm light
adjustable shade flaps

mini par
spot light



○ black (E214) POA
300w spot light

outlet
power



○ white (E111) POA
10 amp power point

board
power



○ white (E113) POA
multi-outlet power board

3-phase
switchboard
power



○ white (E112) POA
30 amp 3-phase switchboard



raised floors, carpet & stages

1m x 1m
stage



● 300mm height (071601) \$60⁰⁰
● 600mm height (071602) \$80⁰⁰
1000 x 1000mm
with black edge trim
*carpet ordered separately

2m x 1m
stage



● 300mm height (071701) \$80⁰⁰
● 600mm height (071702) \$90⁰⁰
2000 x 1000mm
with black edge trim
*carpet ordered separately

steps
stage



● stage steps (071802) \$60⁰⁰
1000(w) x 430(d) x 400(h)mm
for 600mm height stage units
black painted finish

32mm
raised
floor



○ white (071901) \$75⁰⁰
● black (071902) \$85⁰⁰
● beech (071904) \$85⁰⁰
● wenge (071915) \$85⁰⁰
● treadplate (071917) \$120⁰⁰
1x1m laminate timber tiles
32mm height
includes aluminium treadplate
ramped edge

tiles
carpet



● black (072002) \$18⁰⁰
● red (072003) \$20⁰⁰
● dark blue (072005) \$18⁰⁰
● bright blue (072006) \$18⁰⁰
● charcoal (072009) \$18⁰⁰
1x1m carpet tiles



small chrome
sign holder



● chrome (060916) \$70⁰⁰
+ digital print insert \$40⁰⁰
insert size: 290(w) x 420mm(h)
overall height: 1490mm

large chrome
sign holder



● chrome (061016) \$80⁰⁰
+ digital print insert \$110⁰⁰
insert size: 500(w) x 750mm(h)
overall height: 1560mm

A3 product landscape
sign holder



● silver/black (061108) \$75⁰⁰
+ digital print insert \$40⁰⁰
insert size: 420(w) x 297mm(h)
overall height: 840mm

A3 product portrait
sign holder



● silver/black (061208) \$75⁰⁰
+ digital print insert \$40⁰⁰
insert size: 297(w) x 420mm(h)
overall height: 900mm

octa flat
sign frame



● 2m height (062801) \$115⁰⁰
+ digital print panel (s/s) \$275⁰⁰
panel size: 965(w) x 1820mm(h)
single-sided or double-sided

● 2.5m height (062802) \$125⁰⁰
+ digital print panel (s/s) \$335⁰⁰
panel size: 965(w) x 2320mm(h)
single-sided or double-sided

octa curved
sign frame



● 2m height (062901) \$115⁰⁰
+ digital print panel (s/s) \$295⁰⁰
panel size: 1078(w) x 1820mm(h)
single-sided or double-sided

● 2.5m height (062902) \$125⁰⁰
+ digital print panel (s/s) \$375⁰⁰
panel size: 1078(w) x 2320mm(h)
single-sided or double-sided

octa diamond
sign frame



● 2m height (063101) \$100⁰⁰
+ digital print panel (s/s) \$245⁰⁰
panel size: 965(w) x 1650mm(h)
single-sided or double-sided

● 2.5m height (063102) \$110⁰⁰
+ digital print panel (s/s) \$320⁰⁰
panel size: 965(w) x 2090mm(h)
single-sided or double-sided

octa tilted
sign frame



● 2m height (063001) \$100⁰⁰
+ digital print panel (s/s) \$225⁰⁰
panel size: 675(w) x 1500mm(h)
single-sided only

purchase items

fabric mesh
brochure



● black/grey (P111) \$150⁰⁰
portable A4 brochure holder
4 pockets
1350mm height
*purchase item

fabric mesh
brochure



● black/grey (P112) \$180⁰⁰
portable A4 brochure holder
8 pockets
1350mm height
*purchase item

folding
brochure



● silver/clear (P121) \$350⁰⁰
folding A4 brochure holder
double-sided
6 shelves
1430mm height
*purchase item

roll-up
banner



○ black base (P211) \$399⁰⁰
includes printing
portable roll-up banner
banner size: 840(w) x 2000mm(h)
with carry bag
*purchase item

pop-up
banner



○ pop-up (P311) from \$3700⁰⁰
includes printing
portable pop-up curved display
display size: 3365(w) x 2200mm(h)
with hard roller case
*purchase item



SPECIAL TERMS AND CONDITIONS

- 1 **CANCELLATIONS:** All goods cancelled after delivery will be charged at half rate plus CARTAGE & other charges.
- 2 **DAMAGE WAIVER:** Payment of 5% of the hire charges is compulsory – see clause 9 of the general terms and conditions below. Notwithstanding it is the hirer's responsibility to guard equipment against loss or damage until it is collected by the owner.
- 3 **STOCK AVAILABILITY:** Orders for all goods and items listed are subject to stock availability at the time.
- 4 **PRICES & CHARGES:** Subject to change without notice but will not be changed after receipt of order & confirmation payment. All quoted rates are for the duration of the event (maximum 7 days).
- 5 **LATE ORDER SURCHARGE:** Goods being ordered after deadline date will incur a late fee of 20% of sub total.
- 6 **ON SITE ORDERS:** Goods being ordered during exhibitor setup will incur a late fee of 20% of sub total.
- 7 **DELIVERY & PICKUP:** All goods will be delivered the day or morning prior to opening and must be available for collection immediately following closure of the event.
- 8 **HIRERS GOODS:** Owner does not accept any responsibility for hirer's goods left in or on hire goods following closure of exhibition.
- 9 **GST:** All hire items are excluding GST and will attract 10% tax.

GENERAL TERMS AND CONDITIONS

- 1 THE Owner will let on hire to the Hirer for the period and at the rental, the furniture, chattels and effects set out in the Schedule hereto (hereinafter referred to as "the goods").
- 2 THE Hirer shall on the signing hereof pay the full amount of the rental, delivery and damage waiver and the deposit (if applicable) set out on the Order Form.
- 3 THE Hirer must abide by the payment terms set out on the Order Form. Any special agreements made between the Hirer and Owner will be null and void if payment terms are not met.
- 4 THE goods shall be delivered by the Owner at the Hirer's expense to the place of hire on or before the opening date of the event. The Hirer shall, immediately following closure of the event, have the goods available for collection by the Owner at the Hirer's expense.
- 5 IN the event that the goods are not available for collection nor delivered to the Owner on the date of closure, the Hirer shall pay to the Owner the further rent specified in the Catalogue for each additional day of hire until the goods are delivered.
- 6 THE Hirer shall not sell or offer for sale, assign, mortgage, pledge, underlet, lend or otherwise deal with the said goods but will keep the goods in his own possession and will not remove the same or any of them from the place of hire mentioned in the Schedule hereto without the consent of the Owner in writing and will not cause or allow any of the said goods to be so affixed to the premises being the place of hire as to become fixtures and will not create or allow to be created any lien upon the goods and will duly and punctually pay all rates, taxes, charges and impositions payable in respect of the premises whereon the goods shall for the time being be situate and produce all the receipts for such payments to the Owner on demand and will protect the goods against distress, execution or seizure and indemnify the Owner against all losses, costs, charges, damages and expenses incurred by him by reason or in respect thereof.
- 7 THE Hirer shall at all times use the goods in a proper manner and shall at his own expense service, clean and maintain the goods in good and substantial repair and condition reasonable wear and tear expected.
- 8 THE Hirer hereby indemnifies the Owner in respect of any loss or damage to property or persons caused by the use, operation or keeping of the goods for any reason whatsoever during the period of hire
- 9 THE Hirer shall pay to the Owner, in addition to the hire charges, an amount equal to 5% of such hire charges, and in consideration of such payment the Owner agrees to waive the liability of the Hirer for accidental damage to the goods.
- 10 THE Hirer shall be responsible for any loss of goods from any cause whatsoever. The replacement cost of such must be paid forthwith by the Hirer to the Owner.
- 11 IN the event of a break-down or failure of the goods the Hirer shall contact the Owner forthwith and on no account shall repair or attempt to repair the goods without the prior consent of the Owner. In no event shall the Owner be responsible for any expenditure and damages and/or loss incurred by the Hirer arising out of any break-down or failure of the equipment whether caused by fair wear and tear, negligence on the part of the Owner or any other person or any other reason whatsoever.
- 12 THE Hirer shall allow the Owner access at any time during normal business hours to inspect the goods and to enter into and upon any premises where the goods are or are presumed to be for any purpose incidental to or arising out of this agreement.
- 13 THE Owner may notwithstanding the specified period of hire and notwithstanding any waiver of any previous default forthwith terminate this agreement and repossess the goods in any of the following events :
 - (a) if the Hirer fails to pay any hiring charges on or before the due dates,
 - (b) if the Hirer shall do or permit any act or thing to be done whereby the Owner's rights in any of the goods may be prejudiced,
 - (c) if the Hirer shall become or be made insolvent or bankrupt or make any arrangement or composition with his creditors or in the case of a Hirer being a company should an order be made or a resolution passed for winding up on such company,
 - (d) if the Hirer commits any breach of this agreement.
- 14 UPON termination of this agreement for any reason whatsoever the Owner may enter into or upon any premises where the goods may be without prejudice to the rights of the Owner to recover from the Hirer any monies due hereunder or any damages for breach hereof and the Hirer indemnifies the Owner in respect of any claims, damages or expenses arising out of any action taken under this Clause.